

PLCC Series

EMC 3030 Single color

Datasheet

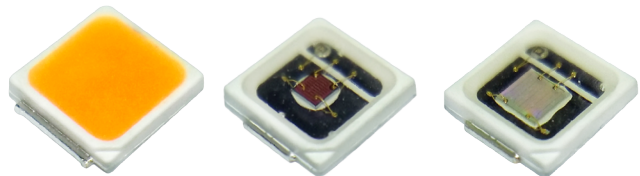

Warning Light



Stage Light

Decorative
Light**Introduction :**

EMC 3030 Single Color Series is a surface-mount LED which uses standard package dimension of 3.0x3.2x0.6mm, enabling drop-in replacement for existing 3030 packages. Besides, EMC package is heat-resistant and especially suitable for high power applications.

Description :

- Industry standard compatible
3.0mmx3.2mm package
- High current operation 500mA Max.
- Wide viewing angle : 115°

Feature and Benefits :

- High luminous Intensity and high efficiency
- Based on Blue : InGaN technology
- Excellent performance and visibility
- Suitable for all SMT assembly methods
- IR reflow process compatible
- Environmental friendly; RoHS compliance
- ANSI Compliant color binning

Table of Contents

General Information.....	3
Absolute Maximum Ratings (Ta=25°C).....	4
Characteristics	4
Luminous Flux Characteristic.....	5
Voltage Bin Structure	5
Wavelength Bin Structure	6
Mechanical Dimensions.....	7
PC Amber Bin Coordinates.....	8
Characteristic curve.....	9
Reflow Profile	14
Reliability.....	15
Product Packaging information.....	16
Revision History	17
About Edison Opto.....	17

General Information

Ordering Code Format

X1		X2		X3-X4		X5-X6		X7-X8		X9-X10		X11-X13		X14-X16	
Type		Component		Series		Wattage		Color		Internal code		PCB Board		Serial Number	
2	Emitter	T	PLCC	12	3030	02	2W	RX	Red	-	-	000	-	-	-
								BX	Blue						
								AX	PC Amber						

Absolute Maximum Ratings (Ta=25°C)

Parameter	Symbol	Value	Units
Forward Current	I_F	500	mA
Pulse Forward Current (tp<=100μs, Duty cycle=0.25)	I_{pulse}	1000	mA
Reverse Current	I_R	10	mA
Reverse Voltage	V_R	[2]	V
LED Junction Temperature	T_J	125	°C
Operating Temperature	-	-40 ~ +85	°C
Storage Temperature	-	-40 ~ +100	°C
ESD Sensitivity (HBM)	V_B	2,000	V
Soldering Temperature	T_s	Reflow Soldering : 255~260°C/10~30sec Manual Soldering : 350°C/3sec	

Notes:

1. Proper current derating must be observed to maintain junction temperature below the maximum at all time.
2. LEDs are not designed to be driven in reverse bias.

Characteristics

Parameter	Symbol	Value	Units
Viewing Angle (Typ.)	$2\theta_{1/2}$	115	Degree
Thermal resistance	-	10	°C/W
Wavelength	-	Red : 620 ~ 630 Blue : 450 ~ 475 PC Amber : 585 ~ 595	-
JEDEC Moisture Sensitivity	-	Level 2a Floor Life Conditions: ≤30°C / 60% RH Soak Requirements(Standard) Time (hours): 120+1/-0 Conditions: 60°C / 60% RH	-

Notes:

1. $2\theta_{1/2}$ is the off-axis angle where the luminous intensity is half of the axial luminous intensity.
2. CIE x/y tolerance: ±0.005

Luminous Flux Characteristic

Luminous Flux Characteristics, $I_f=350\text{mA}$ and $T_j=25^\circ\text{C}$

Color	Group	Min. Luminous flux (lm)	Max. Luminous flux (lm)	Forward Current (mA)	Order Code
Red	Q2	34.8	39.4	350	2T1202RX00000001
	R1	39.4	45.3		
	R2	45.3	51.2		
Blue	P0	23.3	30.3		2T1202BX00000001
	Q0	30.3	39.4		
PC Amber	V1	110	120		2T1202AX19000001
	V2	120	130		
	V3	130	140		

Note:

The luminous flux performance is guaranteed within published operating conditions. Edison Opto maintains a tolerance of $\pm 10\%$ on flux measurements.

Voltage Bin Structure

Color	Group	Min. Voltage (V)	Max. Voltage (V)
Red	U03	1.6	1.9
	U04	1.9	2.2
	U05	2.2	2.5
	V00	2.5	2.8
Blue	V01	2.8	3.1
	V02	3.1	3.4
	V03	3.4	3.7
	V04	3.7	4.1
PC Amber	V01	2.8	3.1
	V02	3.1	3.4
	V03	3.4	3.7
	V04	3.7	4.1

Note:

Forward voltage measurement allowance is $\pm 0.06\text{V}$.

Wavelength Bin Structure

Color	Group	Min. Wd (nm)	Max. Wd (nm)
Red	RX0	620	630
Blue	BU0	450	455
	BV0	455	460
	BW0	460	465
	BX0	465	470
	BY0	470	475
	BZ0	475	480
	PC Amber	A10, A20	585
B10, B20		590	595

Note:
Dominant wavelength Measurement Allowance is $\pm 0.1\text{nm}$

Mechanical Dimensions

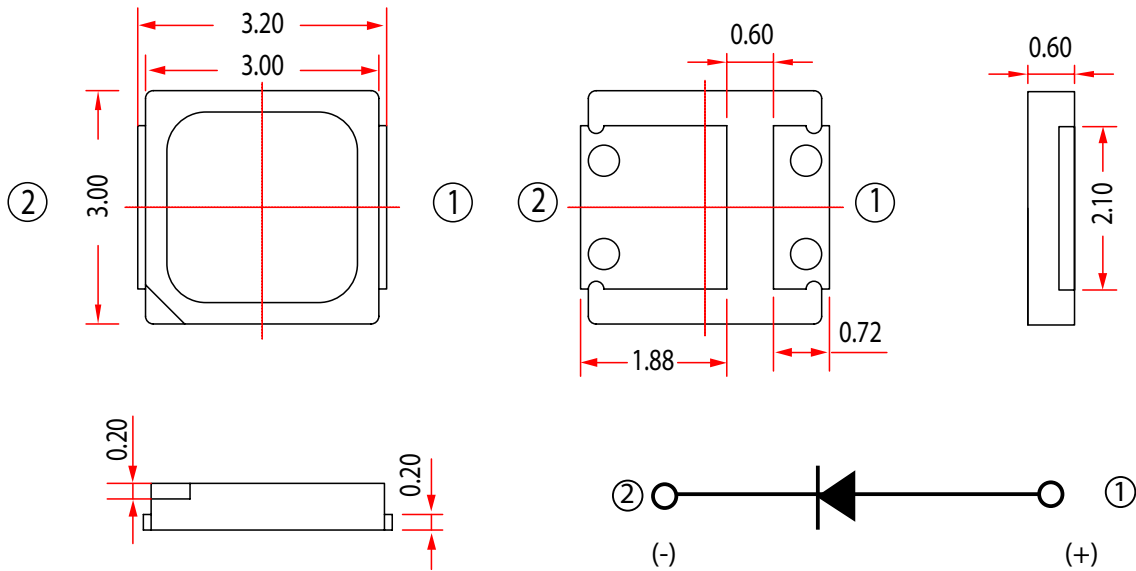

Solder Pad

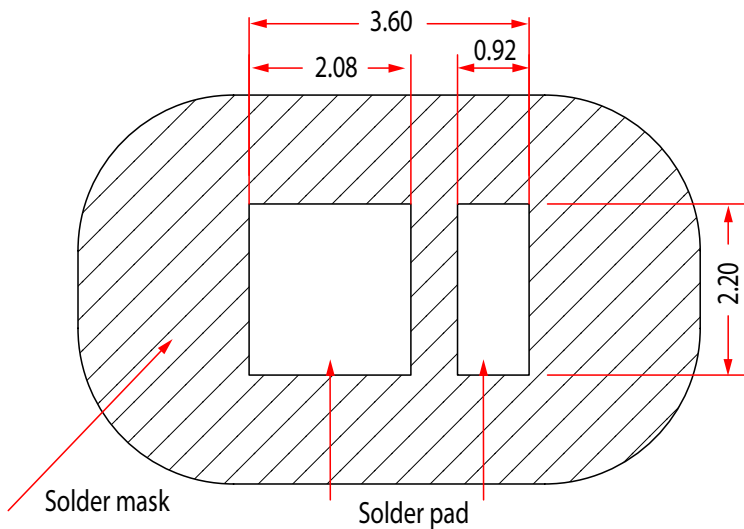

Notes:

1. All dimensions are measured in mm.
2. Tolerance : ± 0.20 mm

PC Amber Bin Coordinates

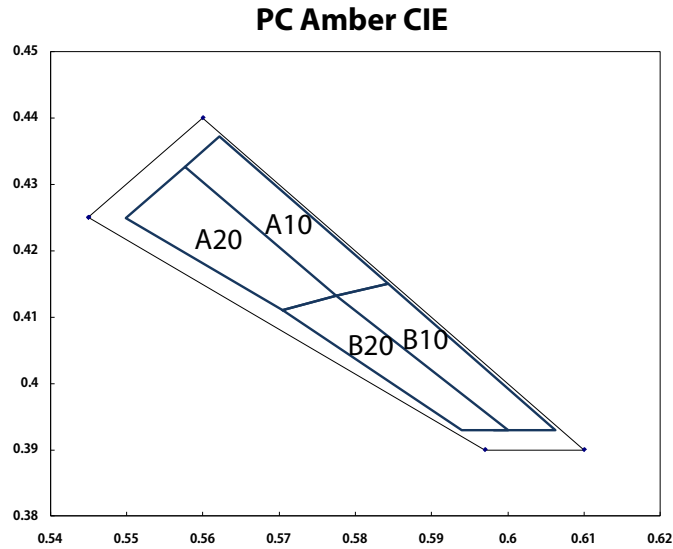

Color Bin	X	Y	Color Bin	X	Y
A10	0.5775	0.4132	A20	0.5705	0.4111
	0.5843	0.4151		0.5775	0.4132
	0.5622	0.4372		0.5576	0.4326
	0.5576	0.4326		0.5499	0.4249
B10	0.5775	0.4132	B20	0.5705	0.4111
	0.5843	0.4151		0.5775	0.4132
	0.6062	0.3930		0.6000	0.3930
	0.5982	0.3930		0.5940	0.3930

Notes:

1. PLCC 3528 PC Amber Emitters are tested and binned by x,y coordinates.
2. Edison maintains a tester tolerance of ± 0.005 on x, y color coordinates.

Characteristic curve

Color Spectrum

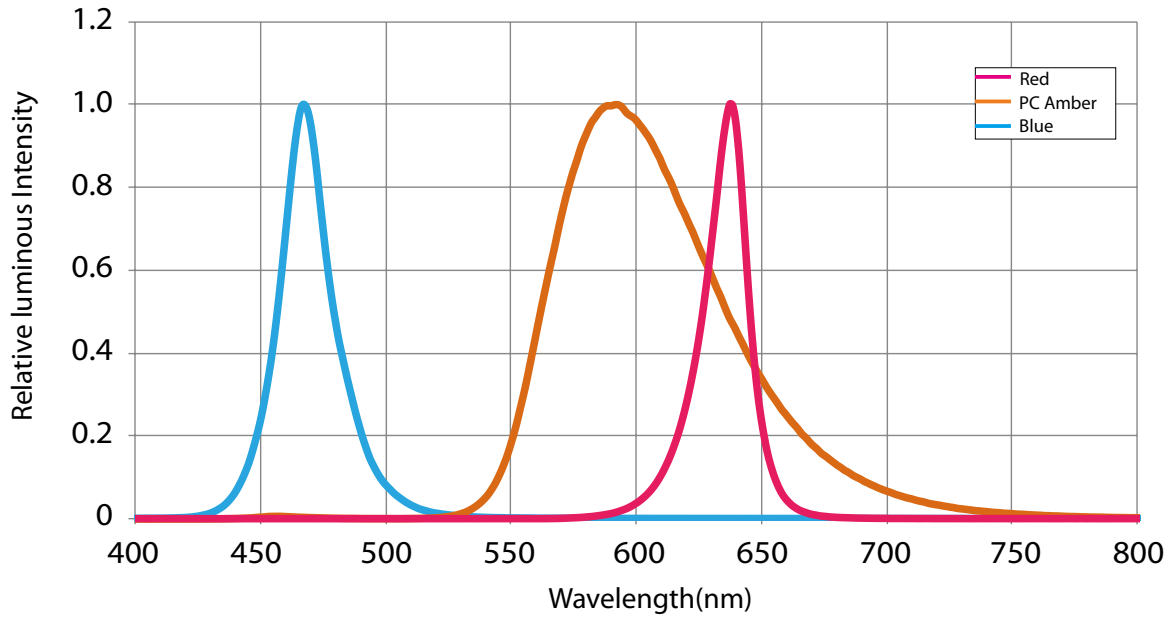

Beam Pattern

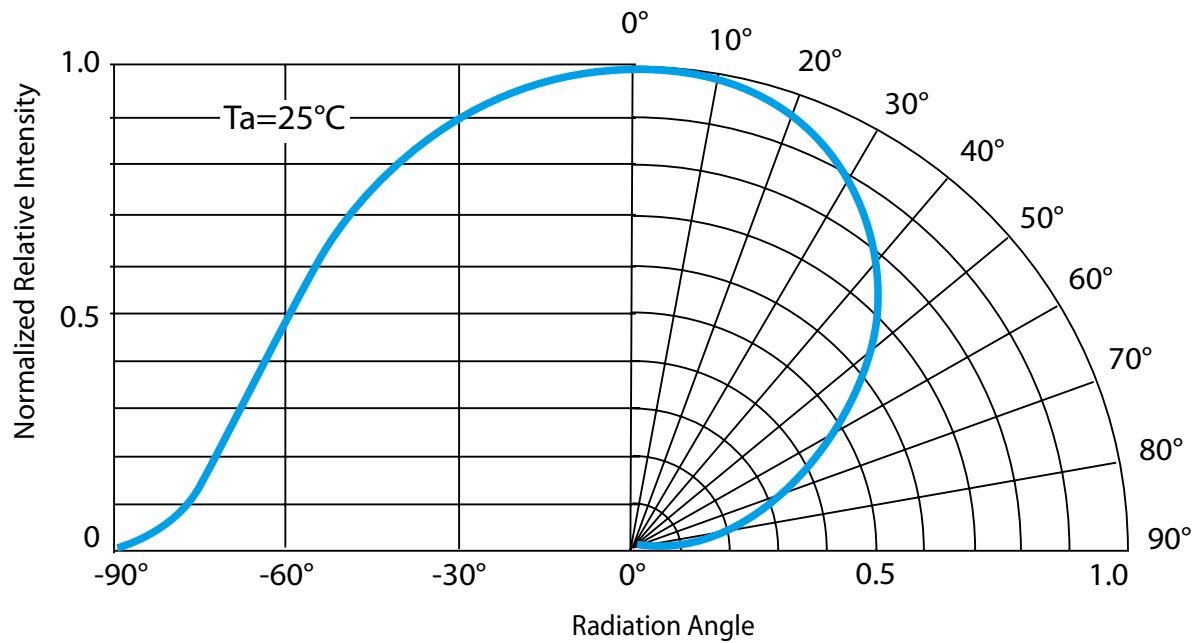

Forward Current vs. Forward Voltage

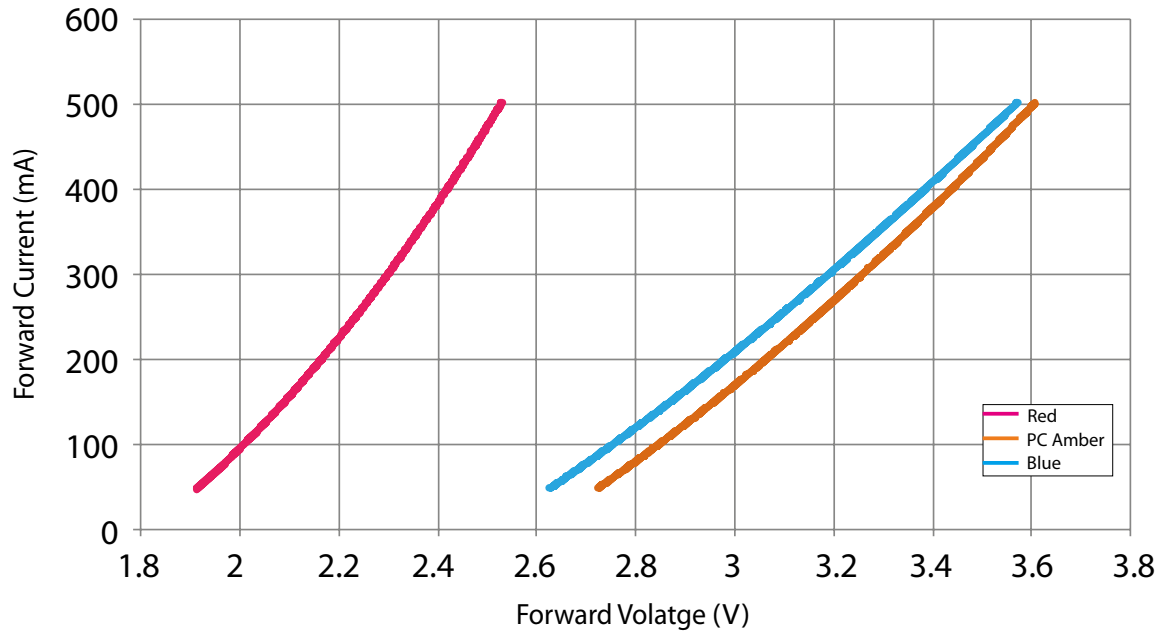

Relative Luminous Intensity vs. Forward Current

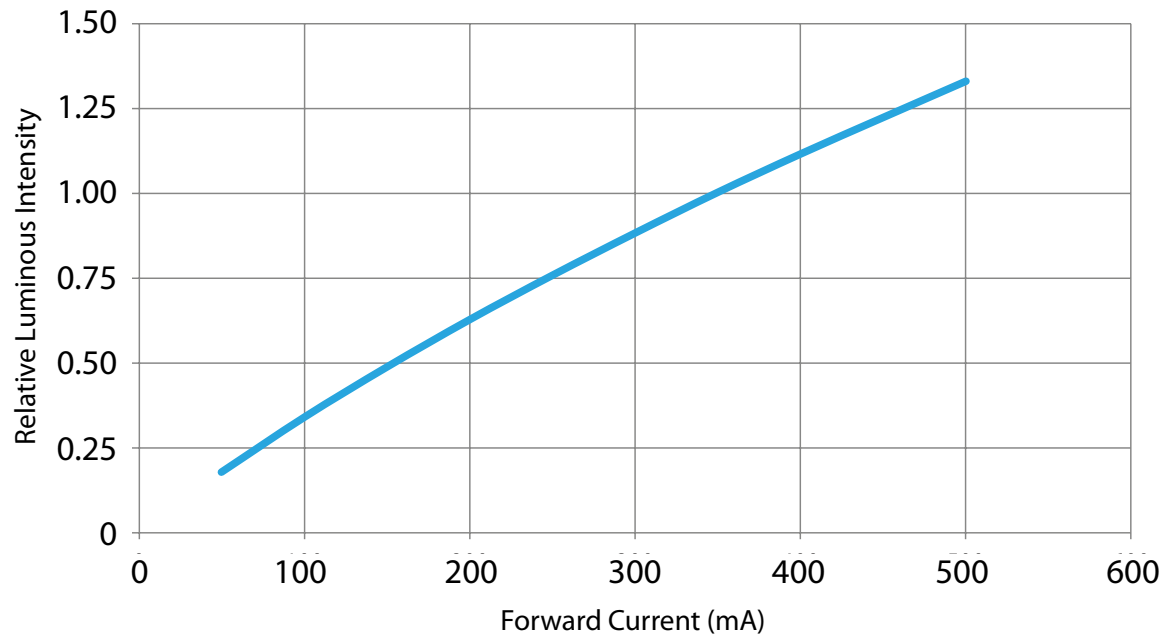

Relative Luminous Flux vs. Junction Temperature

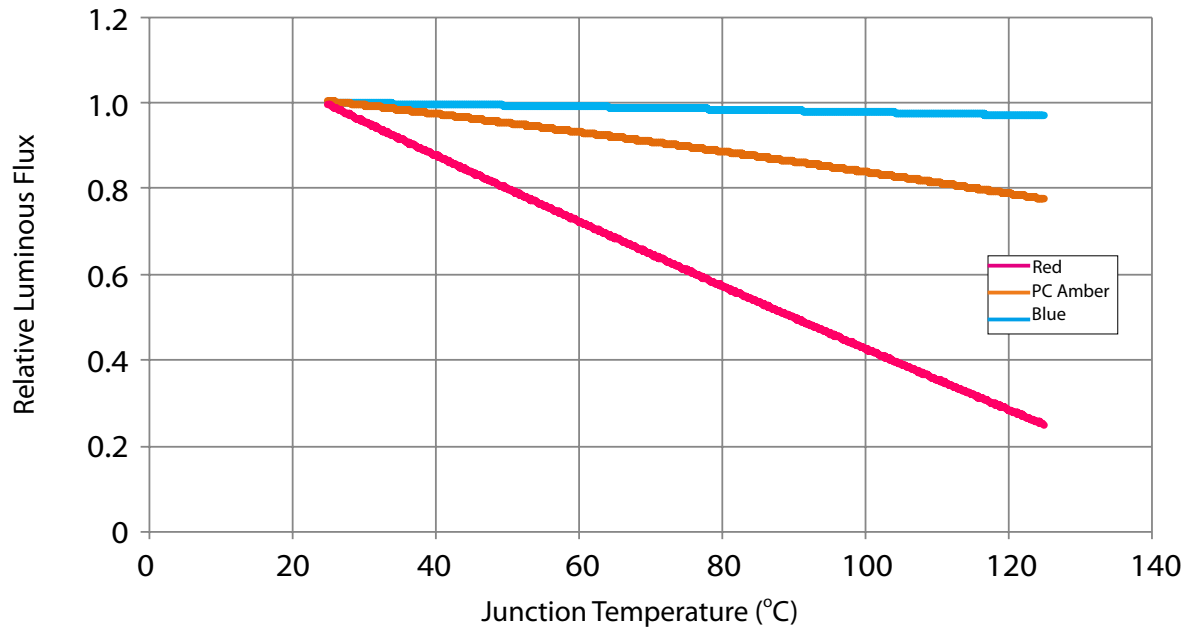

Forward Voltage vs. Junction Temperature

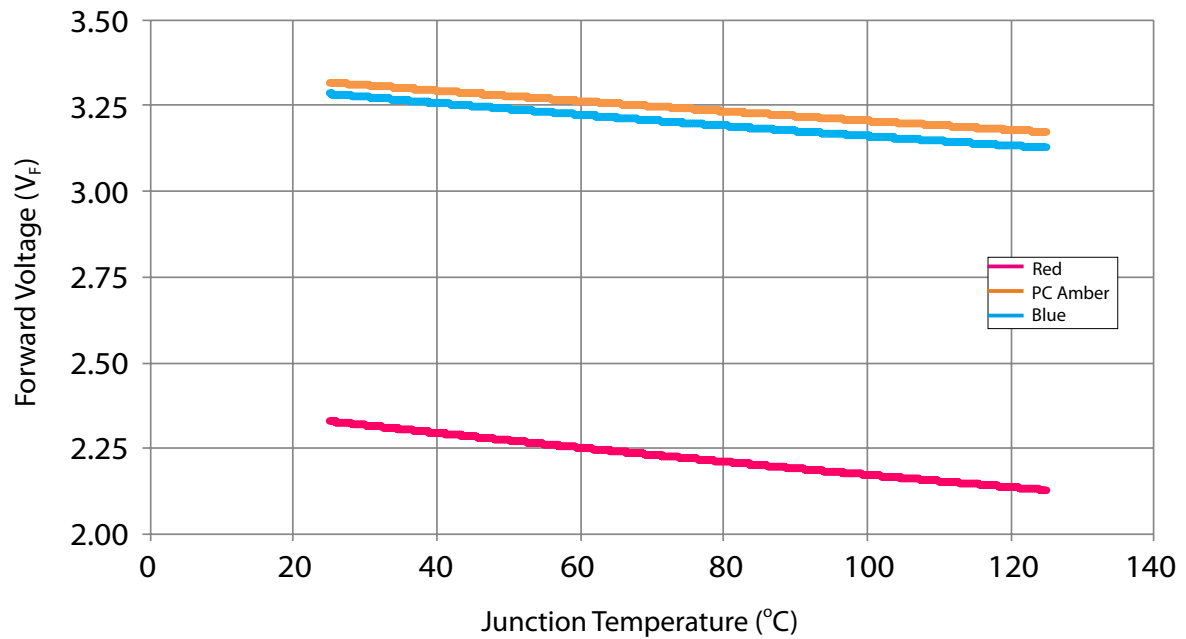

Wavelength vs. Forward Current

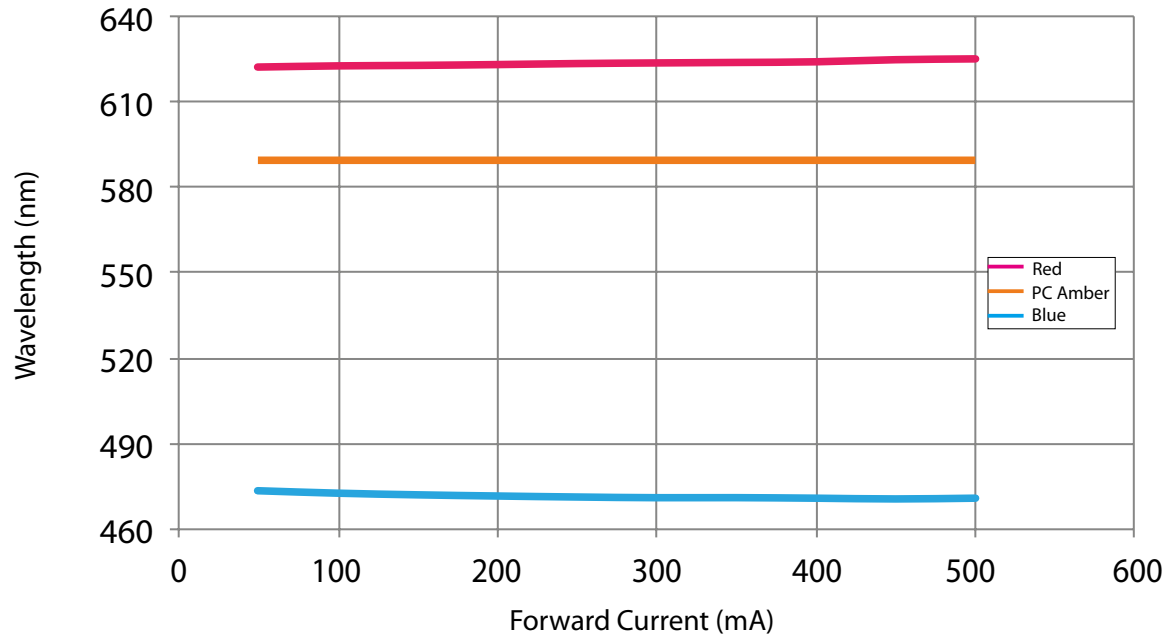

Wavelength vs. Junction Temperature

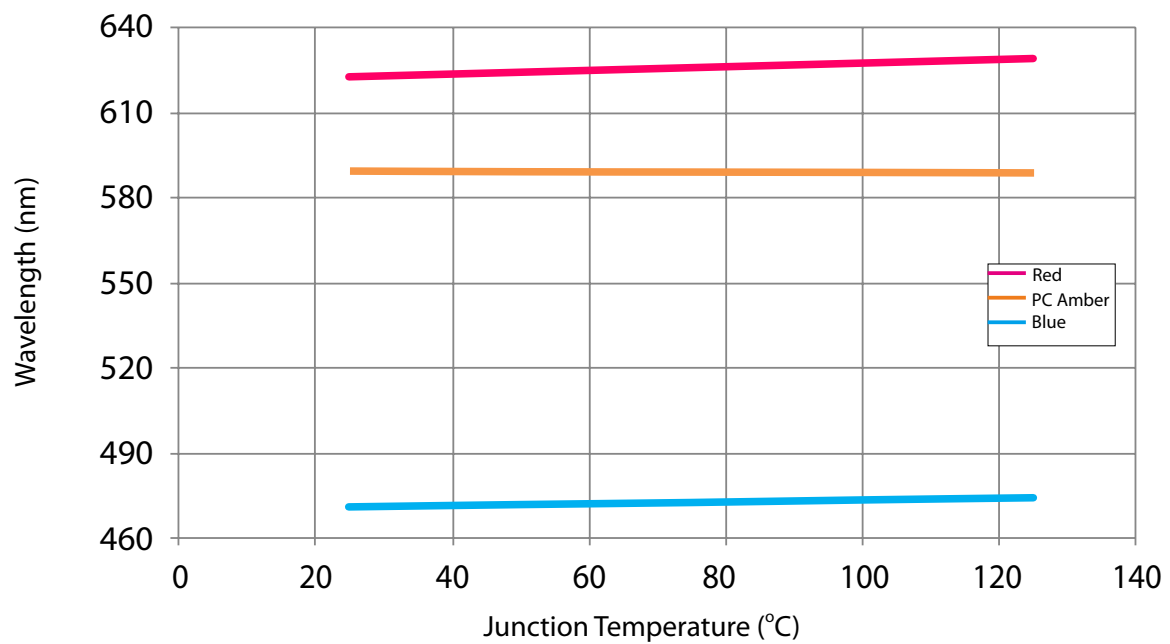

Maximum Current vs. Solder Pad Temperature

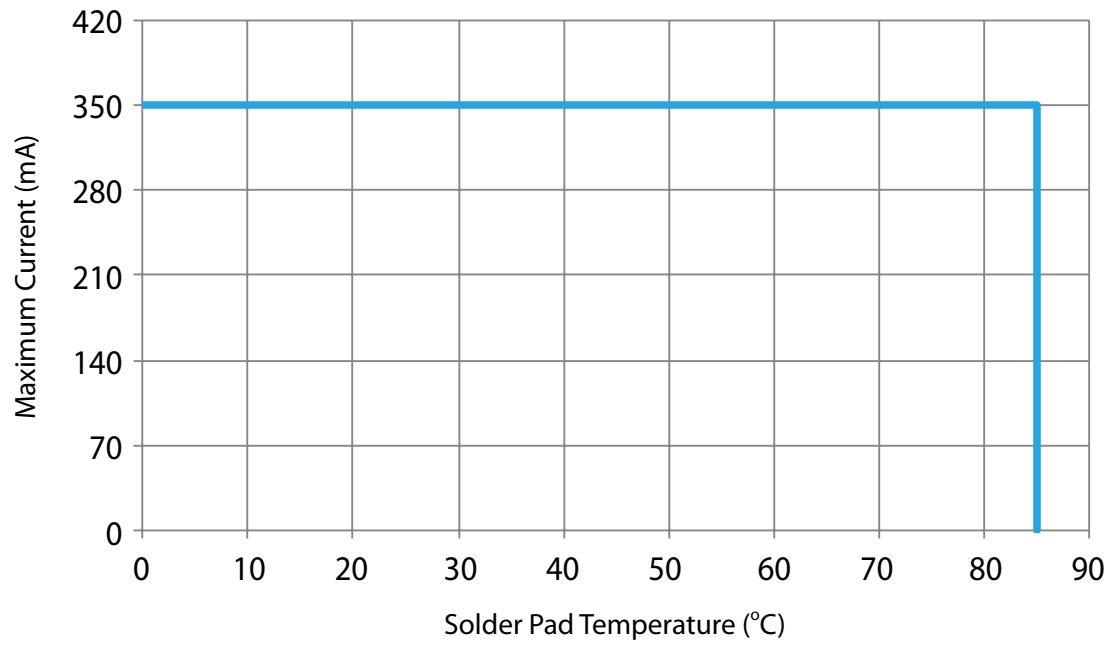

Reflow Profile

The following reflow profile is from IPC/JEDEC J-STD-020D which provided here for reference.

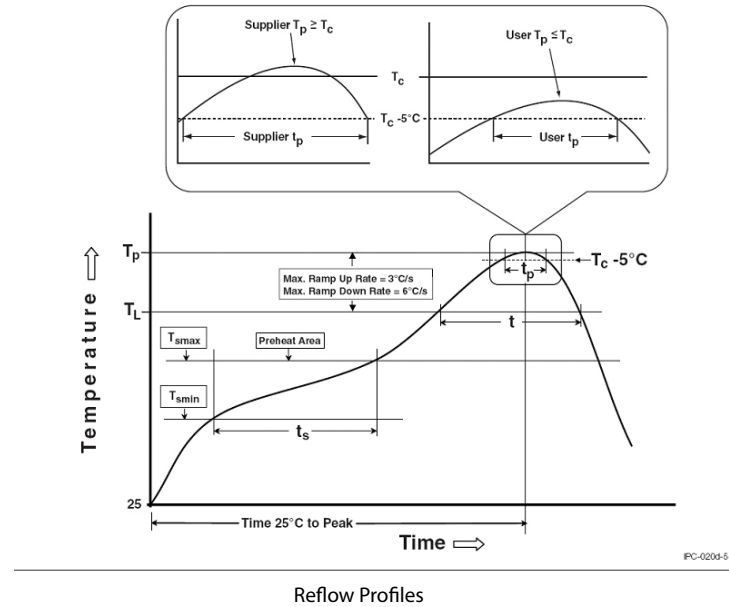

Classification Reflow Profiles

Profile Feature	Pb-Free Assembly
Preheat & Soak Temperature min (T_{smin}) Temperature max (T_{smax}) Time (T_{smin} to T_{smax}) (t_s)	150 °C 200 °C 60-120 seconds
Average ramp-up rate (T_{smax} to T_p)	3 °C/second max.
Liquidous temperature (T_L) Time at liquidous (t_L)	217 °C 60-150 seconds
Peak package body temperature (T_p)*	255 °C ~260 °C *
Classification temperature (T_c)	260 °C
Time (t_p)** within 5 °C of the specified classification temperature (T_c)	30** seconds
Average ramp-down rate (T_p to T_{smax})	6°C/second max.
Time 25°C to peak temperature	8 minutes max.

Notes:

- * Tolerance for peak profile temperature (T_p) is defined as a supplier minimum and a user maximum.
- ** Tolerance for time at peak profile temperature (t_p) is defined as a supplier minimum and a user maximum.

Reliability

NO .	Test Item	Test Condition	Remark
1	Temperature Cycle	-40°C~100°C 30, 30, mins	100 Cycle
2	Thermal Shock	-40°C~100°C 15, 15 mins \leq 10 sec	100 Cycle
3	Resistance to Soldering Heat	T _{SOL} =260°C, 30 sec	3 times
4	Moisture Resistance	25°C~65°C 90% RH 24 hrs / 1 cycle	10 Cycle
5	High-Temperature Storage	T _A =100°C	1,000 hrs
6	Low-Temperature Storage	T _A =-40°C	1,000 hrs
7	Operation Life test	25°C	1,000 hrs
8	High Temperature Operation Life test	85°C	1,000 hrs
9	High Humidity Heat Life Test	85°C, 85%RH	1,000 hrs
10	ON/OFF Test	30 sec ON, 30 sec OFF	1.5W times

Failure Criteria

Item	Criteria for Judgment	
	Min.	Max.
Lumen Maintenance	85%	-
$\Delta u'v'$	-	0.006
Forward Voltage	-	Initial Data x 1.1
Reverse Current	-	10 μ A
Resistance to Soldering Heat	No dead lamps or visual damage	

Product Packaging information

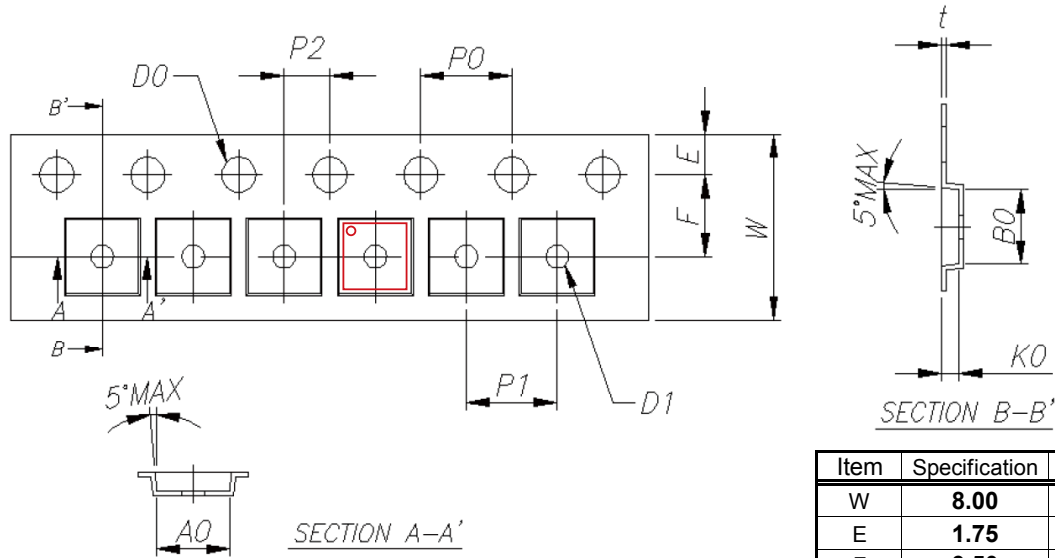

Item	Specification	Tol. (+/-)
W	8.00	± 0.20
E	1.75	± 0.10
F	3.50	± 0.05
D0	1.50	+0.10, -0
D1	1.00	± 0.10
P0	4.00	± 0.10
P1	4.00	± 0.10
P2	2.00	± 0.05
P0 x 10	40.00	± 0.20
t	0.20	± 0.05
A0	3.20	± 0.10
B0	3.20	± 0.10
K0	0.78	± 0.10

Reel Specification

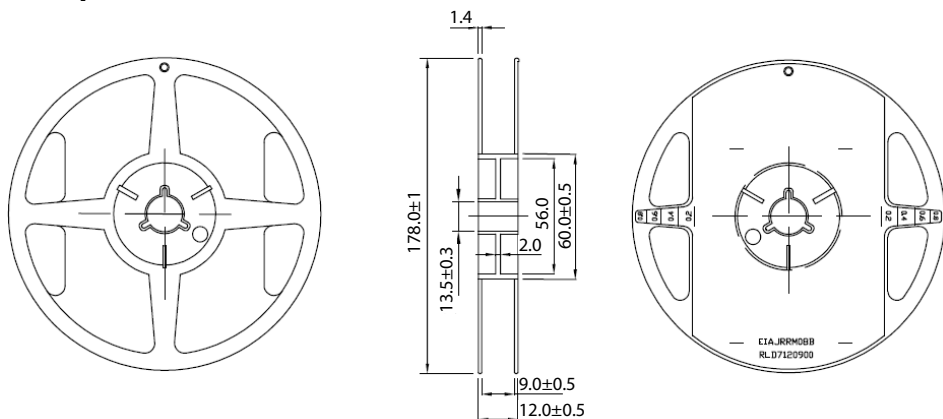

Item	Quantity	Total	Dimensions (mm)
Reel	4,000 pcs	4,000 pcs	R=178
Starting with 150 pcs empty, and 150 pcs empty at the last.			

Revision History

Versions	Description	Release Date
1	Establish a Datasheet	2016/03/10
2	Revise Luminous flux characteristic	2017/04/07

About Edison Opto

Edison Opto is a leading manufacturer of high power LED and a solution provider experienced in LDMS. LDMS is an integrated program derived from the four essential technologies in LED lighting applications- Thermal Management, Electrical Scheme, Mechanical Refinement, Optical Optimization, to provide customer with various LED components and modules. More Information about the company and our products can be found at www.edison-opto.com

Copyright©2017 Edison Opto. All rights reserved. No part of publication may be reproduced or transmitted in any form or by any means, electronic or mechanical, including photo copy, recording or any other information storage and retrieval system, without prior permission in writing from the publisher. The information in this publication are subject to change without notice.

www.edison-opto.com

For general assistance please contact:
service@edison-opto.com.tw

For technical assistance please contact:
LED.Detective@edison-opto.com.tw